

BLUE-MASTER
BY CELESA

PUNTAS DE ATORNILLAR



PUNTAS INTERCAMBIABLES DE ATORNILLAR

REFERENCIA	MATERIAL	LONG.TOTAL	PÁGINA
PHILIPS POZIDRIV PHILIPS REDUCIDA POZIDRIV REDUCIDA RANURA TORX TORX REDONDA CUADRADO ROBERTSON TORX SEGURIDAD CABEZA HEXAGONAL TRI WING XZN	Plus	25mm. LONG. TOTAL	402
PHILIPS POZIDRIV RANURA TORX CUADRADO ROBERTSON CABEZA HEXAGONAL	Plus	50mm. LONG. TOTAL	405
PHILIPS POZIDRIV	Plus	70mm. LONG. TOTAL	407
PHILIPS POZIDRIV	Plus	90mm. LONG. TOTAL	407
PHILIPS POZIDRIV RANURA TORX	TiN	25mm. LONG. TOTAL	408
PHILIPS POZIDRIV TORX	TiN	50mm. LONG. TOTAL	409
PHILIPS POZIDRIV RANURA TORX	DIATiN	25mm. LONG. TOTAL	410

PORTAPUNTAS MAGNÉTICOS

PMG			411
PCR		CON CAMBIO RÁPIDO (APTO PARA PUNTAS DE 1/4" CON CUELLO)	411
PCT		CON ANILLO MAGNÉTICO FRONTAL ADICIONAL	411

LLAVES DE IMPACTO STANDARD EN CAJITAS DE 2 UNIDADES Y EN ESTUCHE DE 7 PIEZAS

PLIHX		50mm. LONG. TOTAL			412
-------	--	-------------------	--	--	-----

DESTORNILLADOR DE CARRACA CON ALMACÉN DE PUNTAS Y EXPOSITOR

DTRC			412
-------------	--	--	-----

ESTUCHES DE PUNTAS DE ATORNILLAR Y EXPOSITORES

		413
--	--	-----

EXTRACTORES DE MÁQUINA PARA TORNILLOS ROTOS EN BLISTER Y ESTUCHES

MICRO GRABIT				416
PRO GRABIT			CON CUERPO HEXAGONAL 1/4"	416
DRILL OUT			CON BROCA GUÍA M6 - M12	416
X-OUT			CON MANGO HEXAGONAL M3 - M5	416

EXTRACTORES DE MANO PARA TORNILLOS ROTOS Y ESTUCHES

EX		417
-----------	--	-----

BROCAS PARA METAL CON MANGO HEXAGONAL 1/4"

REFERENCIA	MATERIAL	AFILADO	ÁNGULO	HÉLICE	ACABADO	MANGO	TIPO / APLICAC.	PÁGINA
BH2	HSS		118°		OX	1/4"	DIN 338	418
BC59	HSS-G					1/4"		418
BH36	HSS		90°			1/4"		418
BH34	HSS		90°			1/4"		418
MAHM	HSS-G					1/4"	BROCA MACHO AVELLANADOR	419
MAHM	HSS-G					1/4"	MACHO	419
AV22	HSS-G					1/4"	AVELLANADOR 3 CORTES	419
AV1..CR	HSS		90°			1/4"	AVELLANADOR DESBARBAR	419
BWH						1/4"		420
BMH	CV					1/4"		420

ESTUCHES DE HERRAMIENTAS CON MANGO HEXAGONAL 1/4"

		420
--	--	-----

PUNTAS INTERCAMBIABLES DE ATORNILLAR



25mm.
LONG.
TOTAL
(L1)



PHILIPS



€ x Punta		2 Uds		5 Uds		50 Uds		100 Uds	
	L ₁ mm.		€		€		€		€
Ph 0	25	Ph0-2	1,89	Ph0-5	1,62	Ph0-50	1,38	Ph0-100	1,33
Ph 1	25	Ph1-2	0,69	Ph1-5	0,54	Ph1-50	0,47	Ph1-100	0,43
Ph 2	25	Ph2-2	0,69	Ph2-5	0,54	Ph2-50	0,47	Ph2-100	0,43
Ph 3	25	Ph3-2	0,69	Ph3-5	0,54	Ph3-50	0,47	Ph3-100	0,43
Ph 4	25	Ph4-2	2,78	Ph4-5	2,44	Ph4-50	2,33	Ph4-100	-

POZIDRIV



€ x Punta		2 Uds		5 Uds		50 Uds		100 Uds	
	L ₁ mm.		€		€		€		€
Pz 0	25	Pz0-2	1,89	Pz0-5	1,62	Pz0-50	1,38	Pz0-100	1,33
Pz 1	25	Pz1-2	0,69	Pz1-5	0,54	Pz1-50	0,47	Pz1-100	0,43
Pz 2	25	Pz2-2	0,69	Pz2-5	0,54	Pz2-50	0,47	Pz2-100	0,43
Pz 3	25	Pz3-2	0,69	Pz3-5	0,54	Pz3-50	0,47	Pz3-100	0,43
Pz 4	25	Pz4-2	2,56	Pz4-5	2,44	Pz4-50	2,33	Pz4-100	-

PHILIPS
REDUCIDA



€ x Punta		2 Uds		5 Uds		50 Uds		100 Uds	
	L ₁ mm.		€		€		€		€
Ph 1	25	Ph1R-2	2,20	Ph1R-5	1,89	Ph1R-50	1,76	Ph1R-100	-
Ph 2	25	Ph2R-2	2,20	Ph2R-5	1,89	Ph2R-50	1,76	Ph2R-100	-
Ph 3	25	Ph3R-2	2,20	Ph3R-5	1,89	Ph3R-50	1,76	Ph3R-100	-

POZIDRIV
REDUCIDA



€ x Punta		2 Uds		5 Uds		50 Uds		100 Uds	
	L ₁ mm.		€		€		€		€
Pz 1	25	Pz1R-2	2,20	Pz1R-5	1,89	Pz1R-50	1,76	Pz1R-100	-
Pz 2	25	Pz2R-2	2,20	Pz2R-5	1,89	Pz2R-50	1,76	Pz2R-100	-
Pz 3	25	Pz3R-2	2,20	Pz3R-5	1,89	Pz3R-50	1,76	Pz3R-100	-

PUNTAS INTERCAMBIABLES DE ATORNILLAR

Plus



25mm.
LONG.
TOTAL
(L₁)



RANURA



€ x Punta		2 Uds		5 Uds		50 Uds		100 Uds	
	L ₁ mm.		€		€		€		€
0,5X3,0	25	PO,5X3,0-2	1,27	PO,5X3,0-5	1,04	PO,5X3,0-50	1,00	PO,5X3,0-100	0,93
0,6X3,5	25	PO,6X3,5-2	1,27	PO,6X3,5-5	1,04	PO,6X3,5-50	1,00	PO,6X3,5-100	0,93
0,5X4,0	25	PO,5X4,0-2	1,27	PO,5X4,0-5	1,04	PO,5X4,0-50	1,00	PO,5X4,0-100	0,93
0,6X4,5	25	PO,6X4,5-2	1,27	PO,6X4,5-5	1,04	PO,6X4,5-50	1,00	PO,6X4,5-100	0,93
0,8X4,0	25	PO,8X4,0-2	1,27	PO,8X4,0-5	1,04	PO,8X4,0-50	1,00	PO,8X4,0-100	0,93
0,8X5,0	25	PO,8X5,0-2	1,27	PO,8X5,0-5	1,04	PO,8X5,0-50	1,00	PO,8X5,0-100	0,93
0,8X5,5	25	PO,8X5,5-2	1,27	PO,8X5,5-5	1,04	PO,8X5,5-50	1,00	PO,8X5,5-100	0,93
1,0X5,5	25	P1X5,5-2	1,27	P1X5,5-5	1,04	P1X5,5-50	1,00	P1X5,5-100	0,93
1,0X6,0	25	P1X6,0-2	1,27	P1X6,0-5	1,04	P1X6,0-50	1,00	P1X6,0-100	0,93
1,2X6,5	25	P1,2X6,5-2	1,27	P1,2X6,5-5	1,04	P1,2X6,5-50	1,00	P1,2X6,5-100	0,93
1,2X8,0	25	P1,2X8,0-2	3,40	P1,2X8,0-5	3,07	P1,2X8,0-50	2,76	P1,2X8,0-100	2,56

TORX



€ x Punta		2 Uds		5 Uds		50 Uds		100 Uds	
	L ₁ mm.		€		€		€		€
T5	25	PT5-2	1,67	PT5-5	1,38	PT5-50	1,24	PT5-100	1,16
T6	25	PT6-2	1,67	PT6-5	1,38	PT6-50	1,24	PT6-100	1,16
T7	25	PT7-2	1,67	PT7-5	1,38	PT7-50	1,24	PT7-100	1,16
T8	25	PT8-2	1,67	PT8-5	1,38	PT8-50	1,24	PT8-100	1,16
T9	25	PT9-2	1,67	PT9-5	1,38	PT9-50	1,24	PT9-100	1,16
T10	25	PT10-2	1,51	PT10-5	1,00	PT10-50	0,93	PT10-100	0,89
T15	25	PT15-2	1,51	PT15-5	1,00	PT15-50	0,93	PT15-100	0,89
T20	25	PT20-2	1,51	PT20-5	1,00	PT20-50	0,93	PT20-100	0,89
T25	25	PT25-2	1,51	PT25-5	1,00	PT25-50	0,93	PT25-100	0,89
T27	25	PT27-2	1,51	PT27-5	1,00	PT27-50	0,93	PT27-100	0,89
T30	25	PT30-2	1,51	PT30-5	1,00	PT30-50	0,93	PT30-100	0,89
T40	25	PT40-2	1,51	PT40-5	1,00	PT40-50	0,93	PT40-100	0,89

TORX
REDONDA



€ x Punta		2 Uds		5 Uds		50 Uds		100 Uds	
	L ₁ mm.		€		€		€		€
TR10	25	PTR10-2	6,89	PTR10-5	6,71	PTR10-50	5,22	PTR10-100	5,10
TR15	25	PTR15-2	6,89	PTR15-5	6,71	PTR15-50	5,22	PTR15-100	5,10
TR20	25	PTR20-2	6,89	PTR20-5	6,71	PTR20-50	5,22	PTR20-100	5,10
TR25	25	PTR25-2	6,89	PTR25-5	6,71	PTR25-50	5,22	PTR25-100	5,10
TR30	25	PTR30-2	6,89	PTR30-5	6,71	PTR30-50	5,22	PTR30-100	5,10
TR40	25	PTR40-2	6,89	PTR40-5	6,71	PTR40-50	5,22	PTR40-100	5,10

CUADRADO
ROBERTSON



€ x Punta		2 Uds		5 Uds		50 Uds		100 Uds	
	L ₁ mm.		€		€		€		€
Nº1	25	PC1-2	2,56	PC1-5	2,42	PC1-50	2,33	PC1-100	2,29
Nº2	25	PC2-2	2,56	PC2-5	2,42	PC2-50	2,33	PC2-100	2,29
Nº3	25	PC3-2	2,56	PC3-5	2,42	PC3-50	2,33	PC3-100	2,29

PUNTAS INTERCAMBIABLES DE ATORNILLAR



25mm.
LONG.
TOTAL
(L₁)



TORX DE
SEGURIDAD



€ x Punta		2 Uds		5 Uds		50 Uds		100 Uds	
	L ₁ mm.		€		€		€		€
TS10	25	PTS10-2	2,51	PTS10-5	2,24	PTS10-50	2,11	PTS10-100	1,93
TS15	25	PTS15-2	2,51	PTS15-5	2,24	PTS15-50	2,11	PTS15-100	1,93
TS20	25	PTS20-2	2,51	PTS20-5	2,24	PTS20-50	2,11	PTS20-100	1,93
TS25	25	PTS25-2	2,51	PTS25-5	2,24	PTS25-50	2,11	PTS25-100	1,93
TS27	25	PTS27-2	2,51	PTS27-5	2,24	PTS27-50	2,11	PTS27-100	1,93
TS30	25	PTS30-2	2,51	PTS30-5	2,24	PTS30-50	2,11	PTS30-100	1,93
TS40	25	PTS40-2	2,51	PTS40-5	2,24	PTS40-50	2,11	PTS40-100	1,93

CABEZA
HEXAGONAL



€ x Punta		2 Uds		5 Uds		50 Uds		100 Uds	
	L ₁ mm.		€		€		€		€
2 mm	25	PHX2-2	1,58	PHX2-5	1,51	PHX2-50	1,42	PHX2-100	1,33
2,5 mm	25	PHX2,5-2	1,58	PHX2,5-5	1,51	PHX2,5-50	1,42	PHX2,5-100	1,33
3 mm	25	PHX3-2	1,58	PHX3-5	1,51	PHX3-50	1,42	PHX3-100	1,33
4 mm	25	PHX4-2	1,58	PHX4-5	1,51	PHX4-50	1,42	PHX4-100	1,33
5 mm	25	PHX5-2	1,58	PHX5-5	1,51	PHX5-50	1,42	PHX5-100	1,33
6 mm	25	PHX6-2	1,58	PHX6-5	1,51	PHX6-50	1,42	PHX6-100	1,33
8 mm	25	PHX8-2	1,58	PHX8-5	1,51	PHX8-50	1,42	PHX8-100	1,33

TRI
WING



€ x Punta		2 Uds		5 Uds		50 Uds		100 Uds	
	L ₁ mm.		€		€		€		€
Nº4	25	PTRW4-2	6,64	PTRW4-5	6,38	PTRW4-50	5,67	PTRW4-100	5,20
Nº5	25	PTRW5-2	6,64	PTRW5-5	6,38	PTRW5-50	5,67	PTRW5-100	5,20
Nº6	25	PTRW6-2	6,64	PTRW6-5	6,38	PTRW6-50	5,67	PTRW6-100	5,20
Nº8	25	PTRW8-2	6,64	PTRW8-5	6,38	PTRW8-50	5,67	PTRW8-100	5,20
Nº10	25	PTRW10-2	6,64	PTRW10-5	6,38	PTRW10-50	5,67	PTRW10-100	5,20

XZN



€ x Punta		2 Uds		5 Uds		50 Uds		100 Uds	
	L ₁ mm.		€		€		€		€
Nº4	25	PXZN4-2	4,42	PXZN4-5	3,91	PXZN4-50	3,73	PXZN4-100	3,58
Nº5	25	PXZN5-2	4,42	PXZN5-5	3,91	PXZN5-50	3,73	PXZN5-100	3,58
Nº6	25	PXZN6-2	4,42	PXZN6-5	3,91	PXZN6-50	3,73	PXZN6-100	3,58
Nº8	25	PXZN8-2	6,64	PXZN8-5	6,13	PXZN8-50	6,02	PXZN8-100	5,80
Nº10	25	PXZN10-2	6,64	PXZN10-5	6,13	PXZN10-50	6,02	PXZN10-100	5,80

PUNTAS INTERCAMBIABLES DE ATORNILLAR

Plus



50mm.
LONG.
TOTAL
(L₁)



PHILIPS



€ x Punta		2 Uds		5 Uds		50 Uds	
	L ₁ mm.		€		€		€
Ph 1	50	Ph1X50-2	2,18	Ph1X50-5	2,04	Ph1X50-50	1,91
Ph 2	50	Ph2X50-2	2,18	Ph2X50-5	2,04	Ph2X50-50	1,91
Ph 3	50	Ph3X50-2	2,18	Ph3X50-5	2,04	Ph3X50-50	1,91
Ph 4	50	Ph4X50-2	-	Ph4X50-5	-	Ph4X50-50	-

POZIDRIV



€ x Punta		2 Uds		5 Uds		50 Uds	
	L ₁ mm.		€		€		€
Pz 1	50	Pz1X50-2	2,18	Pz1X50-5	2,04	Pz1X50-50	1,91
Pz 2	50	Pz2X50-2	2,18	Pz2X50-5	2,04	Pz2X50-50	1,91
Pz 3	50	Pz3X50-2	2,18	Pz3X50-5	2,04	Pz3X50-50	1,91
Pz 4	50	Pz4X50-2	-	Pz4X50-5	-	Pz4X50-50	-

RANURA



€ x Punta		2 Uds		5 Uds		50 Uds	
	L ₁ mm.		€		€		€
0,5X4,0	50	P0,5X4,0X50-2	3,56	P0,5X4,0X50-5	3,47	P0,5X4,0X50-50	3,38
0,5X3,0	50	P0,5X3,0X50-2	3,56	P0,5X3,0X50-5	3,47	P0,5X3,0X50-50	3,38
0,6X3,5	50	P0,6X3,5X50-2	3,56	P0,6X3,5X50-5	3,47	P0,6X3,5X50-50	3,38
0,6X4,5	50	P0,6X4,5X50-2	3,56	P0,6X4,5X50-5	3,47	P0,6X4,5X50-50	3,38
0,8X4,0	50	P0,8X4,0X50-2	3,56	P0,8X4,0X50-5	3,47	P0,8X4,0X50-50	3,38
0,8X5,0	50	P0,8X5,0X50-2	3,56	P0,8X5,0X50-5	3,47	P0,8X5,0X50-50	3,38
0,8X5,5	50	P0,8X5,5X50-2	3,56	P0,8X5,5X50-5	3,47	P0,8X5,5X50-50	3,38
1X5,5	50	P1X5,5X50-2	3,56	P1X5,5X50-5	3,47	P1X5,5X50-50	3,38
1X6,0	50	P1X6,0X50-2	3,56	P1X6,0X50-5	3,47	P1X6,0X50-50	3,38
1,2X6,5	50	P1,2X6,5X50-2	3,56	P1,2X6,5X50-5	3,47	P1,2X6,5X50-50	3,38
1,2X8,0	50	P1,2X8,0X50-2	4,47	P1,2X8,0X50-5	4,38	P1,2X8,0X50-50	4,29

PUNTAS INTERCAMBIABLES DE ATORNILLAR



TORX



€ x Punta		2 Uds		5 Uds		50 Uds	
	L ₁ mm.		€		€		€
T 5	50	PT5X50-2	4,47	PT5X50-5	4,33	PT5X50-50	4,27
T 6	50	PT6X50-2	4,47	PT6X50-5	4,33	PT6X50-50	4,27
T 7	50	PT7X50-2	4,47	PT7X50-5	4,33	PT7X50-50	4,27
T 8	50	PT8X50-2	4,47	PT8X50-5	4,33	PT8X50-50	4,27
T 9	50	PT9X50-2	4,47	PT9X50-5	4,33	PT9X50-50	4,27
T 10	50	PT10X50-2	3,44	PT10X50-5	3,36	PT10X50-50	3,29
T 15	50	PT15X50-2	3,44	PT15X50-5	3,36	PT15X50-50	3,29
T 20	50	PT20X50-2	3,44	PT20X50-5	3,36	PT20X50-50	3,29
T 25	50	PT25X50-2	3,44	PT25X50-5	3,36	PT25X50-50	3,29
T 27	50	PT27X50-2	3,44	PT27X50-5	3,36	PT27X50-50	3,29
T 30	50	PT30X50-2	3,44	PT30X50-5	3,36	PT30X50-50	3,29
T 40	50	PT40X50-2	3,44	PT40X50-5	3,36	PT40X50-50	3,29

CUADRADO ROBERTSON



€ x Punta		2 Uds		5 Uds		50 Uds	
	L ₁ mm.		€		€		€
Nº1	50	PC1X50-2	4,42	PC1X50-5	4,38	PC1X50-50	4,31
Nº2	50	PC2X50-2	4,42	PC2X50-5	4,38	PC2X50-50	4,31
Nº3	50	PC3X50-2	4,42	PC3X50-5	4,38	PC3X50-50	4,31

CABEZA HEXAGONAL



€ x Punta		2 Uds		5 Uds		50 Uds	
	L ₁ mm.		€		€		€
2mm	50	PHX2X50-2	3,93	PHX2X50-5	3,87	PHX2X50-50	3,76
2,5mm	50	PHX2,5X50-2	3,93	PHX2,5X50-5	3,87	PHX2,5X50-50	3,76
3mm	50	PHX3X50-2	3,93	PHX3X50-5	3,87	PHX3X50-50	3,76
4mm	50	PHX4X50-2	3,93	PHX4X50-5	3,87	PHX4X50-50	3,76
5mm	50	PHX5X50-2	3,93	PHX5X50-5	3,87	PHX5X50-50	3,76
6mm	50	PHX6X50-2	3,93	PHX6X50-5	3,87	PHX6X50-50	3,76
8mm	50	PHX8X50-2	5,00	PHX8X50-5	4,96	PHX8X50-50	4,87

PUNTAS INTERCAMBIABLES DE ATORNILLAR

Plus



70mm.
LONG.
TOTAL
(L₁)



PHILIPS



€ x Punta		2 Uds		5 Uds	
	L ₁ mm.		€		€
Ph 1	70	Ph1X70-2	4,78	Ph1X70-5	4,60
Ph 2	70	Ph2X70-2	4,78	Ph2X70-5	4,60
Ph 3	70	Ph3X70-2	4,78	Ph3X70-5	4,60
Ph 4	70	Ph4X70-2	-	Ph4X70-5	-

POZIDRIV



€ x Punta		2 Uds		5 Uds	
	L ₁ mm.		€		€
Pz 1	70	Pz1X70-2	4,78	Pz1X70-5	4,60
Pz 2	70	Pz2X70-2	4,78	Pz2X70-5	4,60
Pz 3	70	Pz3X70-2	4,78	Pz3X70-5	4,60
Pz 4	70	Pz4X70-2	-	Pz4X70-5	-

Plus



90mm.
LONG.
TOTAL
(L₁)



PHILIPS



€ x Punta		2 Uds		5 Uds	
	L ₁ mm.		€		€
Ph 1	90	Ph1X90-2	5,24	Ph1X90-5	5,07
Ph 2	90	Ph2X90-2	5,24	Ph2X90-5	5,07
Ph 3	90	Ph3X90-2	5,24	Ph3X90-5	5,07
Ph 4	90	Ph4X90-2	-	Ph4X90-5	-

POZIDRIV



€ x Punta		2 Uds		5 Uds	
	L ₁ mm.		€		€
Pz 1	90	Pz1X90-2	5,24	Pz1X90-5	5,07
Pz 2	90	Pz2X90-2	5,24	Pz2X90-5	5,07
Pz 3	90	Pz3X90-2	5,24	Pz3X90-5	5,07
Pz 4	90	Pz4X90-2	-	Pz4X90-5	-

PUNTAS INTERCAMBIABLES DE ATORNILLAR

TiN



25mm.
LONG.
TOTAL
(L₁)



PHILIPS



€ x Punta		2 Uds		5 Uds		50 Uds	
	L ₁ mm.		€		€		€
Ph 1	25	Ph1T-2	1,53	Ph1T-5	1,29	Ph1T-50	1,13
Ph 2	25	Ph2T-2	1,53	Ph2T-5	1,29	Ph2T-50	1,13
Ph 3	25	Ph3T-2	1,53	Ph3T-5	1,29	Ph3T-50	1,13

POZIDRIV



€ x Punta		2 Uds		5 Uds		50 Uds	
	L ₁ mm.		€		€		€
Pz 1	25	Pz1T-2	1,53	Pz1T-5	1,29	Pz1T-50	1,13
Pz 2	25	Pz2T-2	1,53	Pz2T-5	1,29	Pz2T-50	1,13
Pz 3	25	Pz3T-2	1,53	Pz3T-5	1,29	Pz3T-50	1,13

RANURA



€ x Punta		2 Uds		5 Uds		50 Uds	
	L ₁ mm.		€		€		€
0,6X4,5	25	PO,6X4,5T-2	1,89	PO,6X4,5T-5	1,67	PO,6X4,5T-50	1,60
0,8X5,5	25	PO,8X5,5T-2	1,89	PO,8X5,5T-5	1,67	PO,8X5,5T-50	1,60
1X5,5	25	P1X5,5T-2	1,89	P1X5,5T-5	1,67	P1X5,5T-50	1,60
1,2X6,5	25	P1,2X6,5T-2	1,89	P1,2X6,5T-5	1,67	P1,2X6,5T-50	1,60

TORX



€ x Punta		2 Uds		5 Uds		50 Uds	
	L ₁ mm.		€		€		€
T 10	25	PT10T-2	2,16	PT10T-5	1,89	PT10T-50	1,80
T 15	25	PT15T-2	2,16	PT15T-5	1,89	PT15T-50	1,80
T 20	25	PT20T-2	2,16	PT20T-5	1,89	PT20T-50	1,80
T 25	25	PT25T-2	2,16	PT25T-5	1,89	PT25T-50	1,80
T 27	25	PT27T-2	2,16	PT27T-5	1,89	PT27T-50	1,80
T 30	25	PT30T-2	2,16	PT30T-5	1,89	PT30T-50	1,80
T 40	25	PT40T-2	2,16	PT40T-5	1,89	PT40T-50	1,80

PUNTAS INTERCAMBIABLES DE ATORNILLAR

TiN



50mm.
LONG.
TOTAL
(L₁)



PHILIPS



€ x Punta		2 Uds		5 Uds		50 Uds	
	L ₁ mm.		€		€		€
Ph 1	50	Ph1Tx50-2	4,24	Ph1Tx50-5	4,13	Ph1Tx50-50	4,00
Ph 2	50	Ph2Tx50-2	4,24	Ph2Tx50-5	4,13	Ph2Tx50-50	4,00
Ph 3	50	Ph3Tx50-2	4,24	Ph3Tx50-5	4,13	Ph3Tx50-50	4,00

POZIDRIV



€ x Punta		2 Uds		5 Uds		50 Uds	
	L ₁ mm.		€		€		€
Pz 1	50	Pz1Tx50-2	4,24	Pz1Tx50-5	4,13	Pz1Tx50-50	4,00
Pz 2	50	Pz2Tx50-2	4,24	Pz2Tx50-5	4,13	Pz2Tx50-50	4,00
Pz 3	50	Pz3Tx50-2	4,24	Pz3Tx50-5	4,13	Pz3Tx50-50	4,00

TORX



€ x Punta		2 Uds		5 Uds		50 Uds	
	L ₁ mm.		€		€		€
T 10	50	PT10Tx50-2	6,78	PT10Tx50-5	6,51	PT10Tx50-50	6,33
T 15	50	PT15Tx50-2	6,78	PT15Tx50-5	6,51	PT15Tx50-50	6,33
T 20	50	PT20Tx50-2	6,78	PT20Tx50-5	6,51	PT20Tx50-50	6,33
T 25	50	PT25Tx50-2	6,78	PT25Tx50-5	6,51	PT25Tx50-50	6,33
T 27	50	PT27Tx50-2	6,78	PT27Tx50-5	6,51	PT27Tx50-50	6,33
T 30	50	PT30Tx50-2	6,78	PT30Tx50-5	6,51	PT30Tx50-50	6,33
T 40	50	PT40Tx50-2	6,78	PT40Tx50-5	6,51	PT40Tx50-50	6,33

PUNTAS INTERCAMBIABLES DE ATORNILLAR

DIATIN



25mm.
LONG.
TOTAL
(L₁)



PHILIPS



€ x Punta		2 Uds		5 Uds		50 Uds	
	L ₁ mm.		€		€		€
Ph 1	25	Ph1D-2	3,53	Ph1D-5	3,22	Ph1D-50	3,16
Ph 2	25	Ph2D-2	3,53	Ph2D-5	3,22	Ph2D-50	3,16
Ph 3	25	Ph3D-2	3,53	Ph3D-5	3,22	Ph3D-50	3,16

POZIDRIV



€ x Punta		2 Uds		5 Uds		50 Uds	
	L ₁ mm.		€		€		€
Pz 1	25	Pz1D-2	3,53	Pz1D-5	3,22	Pz1D-50	3,16
Pz 2	25	Pz2D-2	3,53	Pz2D-5	3,22	Pz2D-50	3,16
Pz 3	25	Pz3D-2	3,53	Pz3D-5	3,22	Pz3D-50	3,16

RANURA



€ x Punta		2 Uds		5 Uds		50 Uds	
	L ₁ mm.		€		€		€
0,6X4,5	25	P0,6X4,5D-2	4,38	P0,6X4,5D-5	4,29	P0,6X4,5D-50	4,16
0,8X5,5	25	P0,8X5,5D-2	4,38	P0,8X5,5D-5	4,29	P0,8X5,5D-50	4,16
1X5,5	25	P1X5,5D-2	4,38	P1X5,5D-5	4,29	P1X5,5D-50	4,16
1,2X6,5	25	P1,2X6,5D-2	4,38	P1,2X6,5D-5	4,29	P1,2X6,5D-50	4,16

TORX



€ x Punta		2 Uds		5 Uds		50 Uds	
	L ₁ mm.		€		€		€
T 10	25	PT10D-2	5,96	PT10D-5	5,53	PT10D-50	5,24
T 15	25	PT15D-2	5,96	PT15D-5	5,53	PT15D-50	5,24
T 20	25	PT20D-2	5,96	PT20D-5	5,53	PT20D-50	5,24
T 25	25	PT25D-2	5,96	PT25D-5	5,53	PT25D-50	5,24
T 27	25	PT27D-2	5,96	PT27D-5	5,53	PT27D-50	5,24
T 30	25	PT30D-2	5,96	PT30D-5	5,53	PT30D-50	5,24
T 40	25	PT40D-2	5,96	PT40D-5	5,53	PT40D-50	5,24

PORTAPUNTAS MAGNÉTICOS

PORTAPUNTAS MAGNÉTICOS

	L ₁ mm.	TIPO DE MANGO	€
PMGx51	51	MAGNÉTICO SIN ANILLO	4,51
PMGx58	58	MAGNÉTICO SIN ANILLO	4,64
PMGx74	74	MAGNÉTICO CON ANILLO	10,28
PMGx100	100	MAGNÉTICO CON ANILLO	11,87
PMGx200	200	MAGNÉTICO CON ANILLO	19,01
PMGx250	250	MAGNÉTICO CON ANILLO	22,73
PMGSDSx78	78	SDS PLUS	20,08
PBERx74	74	BERILIO	41,69
PDESSx70	70	5/16" DESSOUTTER	25,69
P5,5x72	72	5.5mm Bosch	31,87
P7x74	74	7mm Fein	27,91



Ref. **PMGSDSX78**

Ref. **PMGX74**

Ref. **PMGX100**

PORTAPUNTAS MAGNÉTICO CON CAMBIO RÁPIDO (APTO PARA PUNTAS DE 1/4" CON CUELLO)

	L ₁ mm.	TIPO DE MANGO	€
PCRX60 *	60	Cambio rápido 1/4" Apto para puntas de 1/4" con cuello	12,99
PCRX74 *	74	Cambio rápido 1/4" Apto para puntas de 1/4" con cuello	13,39
PCRSDSX80	80	SDS PLUS	26,35
PCRDESSX70	70	Cambio dessoutter	35,56
PCR5,5X72	72	Cambio 5.5mm Bosch	35,56
PCR7X4	74	Cambio Fein 7mm	35,56



Ref. **PCRSDSX80**

Ref. **PCRX60**



PORTAPUNTAS MAGNÉTICO CON ANILLO MAGNÉTICO FRONTAL ADICIONAL



Ref. **PCTX60**

	L ₁ mm.	TIPO DE MANGO	€
PCTX60	60	Portapuntas con tope regulable	12,24
PCTRX60	60	Portapuntas cambio rápido	14,05

LLAVES DE IMPACTO STANDARD



50 mm.
LONG.
TOTAL



VASO HEXAGONAL MAGNÉTICO



€ x Vaso	mm.		2 Uds
		pulgadas	€
PLHX5-2	5,0		6,75
PLHX5,5-2	5,5		6,75
PLHX6-2	6,0		6,75
PLHX1/4-2		1/4"	6,45
PLHX7-2	7,0		6,45
PLHX8-2	8,0		6,45
PLHX5/16-2		5/16"	6,45
PLHX10-2	10,0		6,72
PLHX11-2	11,0		7,58
PLHX12-2	12,0		7,58
PLHX13-2	13,0		7,58
PLHX3/8-2		3/8"	7,58

ESTUCHES DE 7 PIEZAS DE LLAVES DE IMPACTO STANDARD



REFERENCIA	EPLL
Nº LLAVES	7
CONTENIDO	HX1/4 - HX7 - HX8 - HX3/8 HX10 - HX12 - HX13
P.V.P. €	47,47

DESTORNILLADOR DE CARRACA CON ALMACÉN DE PUNTAS Y EXPOSITOR PARA DESTORNILLADORES



1. Alta calidad y rendimiento
2. Giro a derechas y a izquierdas
3. Caña telescópica ajustable en longitud
4. Fabricado en acero y plástico de alta resistencia

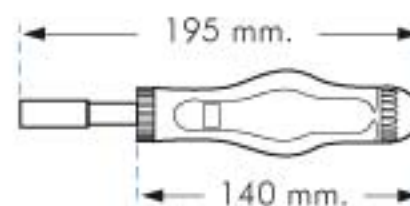
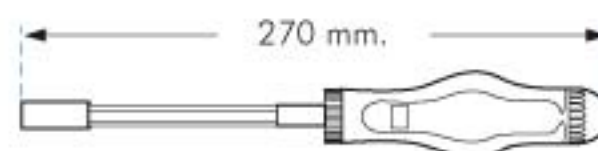

DTRC	
Contenido del destornillador	<ul style="list-style-type: none"> ⊕ PH1 - PH2 ⊕ PZ1 - PZ2 ⊛ T15 - T20 - T25 - T30
25,00 €	



EXDTRC	
	Expositor con 12 Destornilladores
	Ref. DTRC
300,00 €	

ESTUCHES DE PUNTAS INTERCAMBIABLES DE ATORNILLAR

ESTUCHES DE 7 PIEZAS CALIDAD PLUS, TiN Y DiATiN

	REFERENCIA Nº PUNTAS CONTENIDO	EPT1 7 + PH1 - PH2 + PZ1 - PZ2 - 0,8x5,5 - 1,2x6,5 1 Portapuntas PMG	EPT2 7 T10 - T15 * T20 - T25 T30 - T40 1 Portapuntas PMG	EPT3 7 + PH1 - PH2 - PH3 + PZ1 - PZ2 - PZ3 1 Portapuntas PMG
	Plus P.V.P. €	10,29	13,88	12,33
	REFERENCIA Nº PUNTAS CONTENIDO	EPTT1 7 + PH1 - PH2 + PZ1 - PZ2 - 0,8x5,5 - 1,2x6,5 1 Portapuntas PMG	EPTT2 7 T10 - T15 * T20 - T25 T30 - T40 1 Portapuntas PMG	EPTT3 7 + PH1 - PH2 - PH3 + PZ1 - PZ2 - PZ3 1 Portapuntas PMG
	TiN P.V.P. €	29,20	33,85	28,15
	REFERENCIA Nº PUNTAS CONTENIDO	EPTD1 7 + PH1 - PH2 + PZ1 - PZ2 - 0,8x5,5 - 1,2x6,5 1 Portapuntas PMG	EPTD2 7 T10 - T15 * T20 - T25 T30 - T40 1 Portapuntas PMG	EPTD3 7 + PH1 - PH2 - PH3 + PZ1 - PZ2 - PZ3 1 Portapuntas PMG
	DIATiN P.V.P. €	42,55	47,80	40,40

ESTUCHES DE 12 PIEZAS CALIDAD PLUS, TiN Y DiATiN

	REFERENCIA Nº PUNTAS CONTENIDO	EPT4 12 + PH1 - PH2(2) - PH3 + PZ1 - PZ2(2) - PZ3 - 0,6x4,5 - 0,8x5,5 - 1,2x6,5 1 Portapuntas PMG	EPT5 12 T10 - T15(2) * T20(2) - T25(2) T27 - T30(2) - T40 1 Portapuntas PMG
	Plus P.V.P. €	13,80	18,95
	REFERENCIA Nº PUNTAS CONTENIDO	EPTT4 12 + PH1 - PH2(2) - PH3 + PZ1 - PZ2(2) - PZ3 - 0,6x4,5 - 0,8x5,5 - 1,2x6,5 1 Portapuntas PCT	EPTT5 12 T10 - T15(2) * T20(2) - T25(2) T27 - T30(2) - T40 1 Portapuntas PCT
	TiN P.V.P. €	36,75	43,25
	REFERENCIA Nº PUNTAS CONTENIDO	EPTD4 12 + PH1 - PH2(2) - PH3 + PZ1 - PZ2(2) - PZ3 - 0,6x4,5 - 0,8x5,5 - 1,2x6,5 1 Portapuntas PCR	EPTD5 12 T10 - T15(2) * T20(2) - T25(2) T27 - T30(2) - T40 1 Portapuntas PCR
	DIATiN P.V.P. €	57,25	66,60

ESTUCHES DE PUNTAS INTERCAMBIABLES DE ATORNILLAR

ESTUCHES DE 31 PIEZAS CALIDAD PLUS, TiN Y DiATiN

Ref. **EPT6**



REFERENCIA Nº PUNTAS CONTENIDO  P.V.P. €	EPT6 31 ⊕ PH1 (3) - PH2(3) - PH3(3) ⊕ PZ1 (3) - PZ2(3) - PZ3(3) ⊖ 0,6x4,5 - 0,8x5,5 - 1,2x6,5	⊕ T10 - T15 - T20 - T25 - T30 - T40 ○ H3 - H4 - H5 1 Portapuntas PMG
	39,45	
REFERENCIA Nº PUNTAS CONTENIDO  P.V.P. €	EPTT6 31 ⊕ PH1 (3) - PH2(3) - PH3(3) ⊕ PZ1 (3) - PZ2(3) - PZ3(3) ⊖ 0,6x4,5 - 0,8x5,5 - 1,2x6,5	⊕ T10 - T15 - T20 - T25 - T30 - T40 ○ H3 - H4 - H5 1 Portapuntas PCT
	83,70	
REFERENCIA Nº PUNTAS CONTENIDO  P.V.P. €	EPTD6 31 ⊕ PH1 (3) - PH2(3) - PH3(3) ⊕ PZ1 (3) - PZ2(3) - PZ3(3) ⊖ 0,6x4,5 - 0,8x5,5 - 1,2x6,5	⊕ T10 - T15 - T20 - T25 - T30 - T40 ○ H3 - H4 - H5 1 Portapuntas PCR
	142,00	



ESTUCHES DE 36 PIEZAS CALIDAD PLUS Y TiN



Ref. **EPT7**



Ref. **EPTT7**

REFERENCIA Nº PUNTAS CONTENIDO  P.V.P. €	EPT7 36 ⊕ PH1 (3) - PH2(3) - PH3(3) ⊕ PZ1 (3) - PZ2(3) - PZ3(3) ⊖ 0,5 x 4 - 0,6 x 4,5 - 0,8 x 5 - 0,8 x 5,5 - 1 x 6 - 1,2 x 6,5 - 1,2 x 8 1 Portapuntas PMG	⊕ T10 - T15 - T20 - T25 - T27 - T30 - T40 ○ H2 - H2,5 - H3 - H4 - H5 - H6 - H8
	49,95	
REFERENCIA Nº PUNTAS CONTENIDO  P.V.P. €	EPTT7 36 ⊕ PH1 (3) - PH2(3) - PH3(3) ⊕ PZ1 (3) - PZ2(3) - PZ3(3) ⊖ 0,5 x 4 - 0,6 x 4,5 - 0,8 x 5 - 0,8 x 5,5 - 1 x 6 - 1,2 x 6,5 - 1,2 x 8 1 Portapuntas PCT	⊕ T10 - T15 - T20 - T25 - T27 - T30 - T40 ○ H2 - H2,5 - H3 - H4 - H5 - H6 - H8
	102,50	

ESTUCHES DE PUNTAS INTERCAMBIABLES DE ATORNILLAR

ESTUCHES DE 80 PIEZAS CALIDAD *Plus*



REFERENCIA
Nº PUNTAS
CONTENIDO

Plus

P.V.P. €

EPT80
80

- ⊕ PH0 - PH1 - PH2(4) - PH3(2)
- ⊕ PZ1 - PZ2(4) - PZ3(2)
- ⊖ 0,5 x 3 - 0,6 x 4,5 - 0,8 x 5,5(2) - 1,2 x 6,5 - 1,6 x 8
- H2 - H2,5 - H3 - H4 - H5 - H6 - H7 - H8
- ⊙ TW1 - TW2 - TW3 - TW4 - TW5
- ⊕ TQ5 - TQ6 - TQ8 - TQ10
- ⊕ TS10 - TS15 - TS20 - TS25 - TS30 - TS40
- ⊕ T5 - T6 - T7 - T8 - T9 - T10 - T15 - T20(2) - T25(2) - T27 - T30 - T40
- C0 - C1 - C2 - C3
- ⊖ SP4 - SP6 - SP8 - SP10
- ⊙ HS3 - HS4 - HS5 - HS6
- 1 Portapuntas PCR

149,00

EXPOSITORES DE SOBREMESA PARA ESTUCHES DE 36 Y 80 PIEZAS



EXEPT7
10 Estuches de 36 piezas

Plus

Ref. **EPT7**

499,50 €



EXEPTT7
10 Estuches de 36 piezas

TIN

Ref. **EPTT7**

1.025,00 €



EXEPT80
5 Estuches de 80 piezas

Plus

Ref. **EPT80**

745,00 €

EXTRACTORES DE MÁQUINA PARA TORNILLOS ROTOS

MICRO GRABIT



		EP
		€
EP451C	M3	35,12
EP452C	M4	35,12
EP453C	M5	35,12
EP454C	M6	35,12

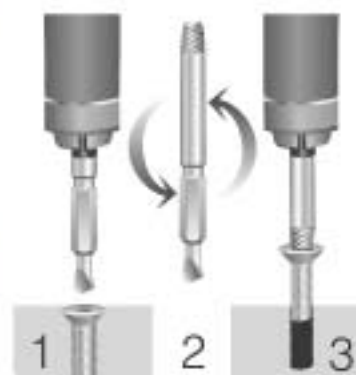

1. Taladrar el tornillo
2. Dar la vuelta.
3. Extraer



PRO GRABIT CON CUERPO HEXAGONAL 1/4"



		EP
		€
EP8401C	M5	27,87
EP8402C	M6	32,91
EP8403C	M8	32,91
EP8404C	M10	34,55

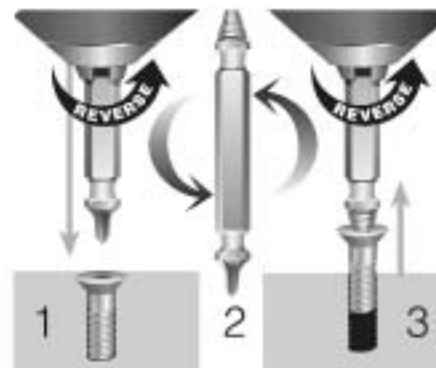

1. Taladrar el tornillo
2. Dar la vuelta.
3. Extraer



DRILL-OUT EXTRACTOR DE TORNILLOS ROTOS CON BROCA GUÍA (M6-M12)



		EP
		€
EP205C	M6	34,07
EP312C	M8	41,27
EP375C	M10	41,27
EP500C	M12	46,47

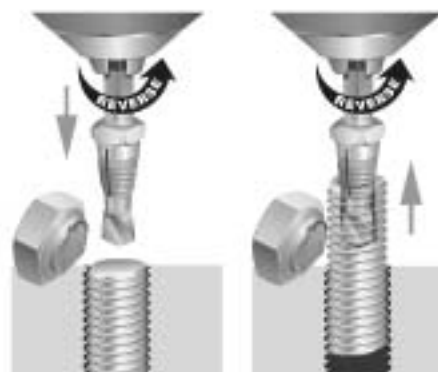

X-OUT EXTRACTOR DE TORNILLOS ROTOS CON MANGO HEXAGONAL (M3-M5)



		EP
		€
EP3701C	M3	27,87
EP3702C	M4	27,87
EP3703C	M5	30,97

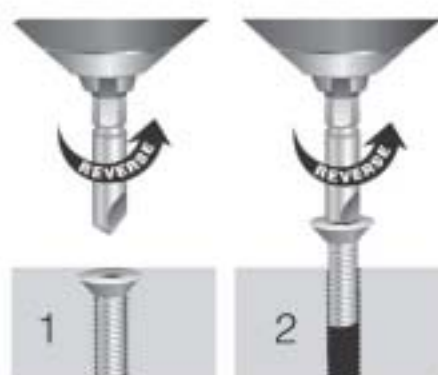

ESTUCHES DE EXTRACTORES DE MÁQUINA PARA TORNILLOS ROTOS

MICROGRABIT



REFERENCIA	EP450C
Nº PIEZAS	4
CONTENIDO	M3-M4-M5-M6
P.V.P. €	144,11

PROGRABIT



REFERENCIA	EP8420C
Nº PIEZAS	2
CONTENIDO	M5-M6
P.V.P. €	58,91



REFERENCIA	EP8430C
Nº PIEZAS	3
CONTENIDO	M5-M6-M8
P.V.P. €	85,91



REFERENCIA	EP8440C
Nº PIEZAS	4
CONTENIDO	M5-M6-M8-M10
P.V.P. €	117,91

DRILL-OUT



REFERENCIA	EP401C
Nº PIEZAS	4
CONTENIDO	M6-M8-M10-M12
P.V.P. €	169,52

MIXTOS



REFERENCIA	EP701C
Nº PIEZAS	7
CONTENIDO	MICRO GRABIT (M3-M6) DRILL OUT (M8-M12)
P.V.P. €	237,33



REFERENCIA	EP100C
Nº PIEZAS	10
CONTENIDO	X OUT (M3-M5) - MICRO GRABIT (M3-M6) DRILL OUT (M8-M12)
P.V.P. €	265,18

EXTRACTORES DE MANO PARA TORNILLOS ROTOS

JUEGOS DE EXTRACTORES CLÁSICOS DE TORNILLOS

Taladrar un agujero central con la broca Blue-Master recomendada; Introducir el extractor en el agujero, haciendo girar el extractor hacia la izquierda, hasta extraer el tornillo.

REFERENCIA	EX/1-5	EX/1-6	EX/1-8
Nº PIEZAS	5	6	8
CONTENIDO	M3 - M18	M3 - M24	M3 - M45
P.V.P. €	13,07	18,46	40,80



Ref. EX/1-6

EXTRACTORES SUELTOS



	Para TORNILLOS	∅ mm.	∅ mm.	L ₁ mm.	∅ max mm.	∅ min mm.	EX €
EX/1	M3 - M6	3,2	2,5	51	1,75	3,95	1,73
EX/2	M6 - M8	4,0	3,0	60	2,20	4,80	1,73
EX/3	M8 - M11	5,1	4,5	68	3,30	6,40	2,05
EX/4	M11 - M14	6,2	6,0	76	4,75	8,40	2,54
EX/5	M14 - M18	8,6	8,0	86	6,35	11,00	3,30
EX/6	M18 - M24	12,0	11,0	95	9,50	15,00	5,59
EX/7	M24 - M33	15,9	14,0	105	12,70	19,00	15,14
EX/8	M33 - M50	20,0	21,0	111	19,00	25,00	24,80



REFERENCIA	EXTT
Nº PIEZAS	10
EXTRACTORES	EX/1-EX/2-EX/3-EX/4-EX/5
BROCAS PREVIAS	Ref. BC3 ∅1-3-4-5-6-8
P.V.P. €	23,25

HERRAMIENTAS CON MANGO HEXAGONAL 1/4"

BROCA PARA METAL DIN 338



	BH2			
	∅ mm.	L ₁ x L ₂ mm.		€
BH20300	3,00	61 x 33	1/4"	4,29
BH20400	4,00	75 x 43	1/4"	4,97
BH20500	5,00	86 x 52	1/4"	6,18
BH20600	6,00	93 x 57	1/4"	6,67
BH20700	7,00	109 x 69	1/4"	8,40
BH20800	8,00	117 x 75	1/4"	9,44
BH20900	9,00	125 x 81	1/4"	10,62
BH21000	10,00	133 x 87	1/4"	11,82

BROCA PARA METAL EXTRA CORTA



	BC59		
∅	L ₁ x L ₂ mm.		€
1,00	34 x 12	1/4"	5,37
1,50	34 x 12	1/4"	5,37
2,00	34 x 12	1/4"	5,37
2,50	36 x 14	1/4"	5,37
3,00	38 x 16	1/4"	5,37
3,30	40 x 18	1/4"	5,37
3,50	40 x 18	1/4"	5,37
4,00	44 x 20	1/4"	5,37
4,20	45 x 20	1/4"	5,37
4,50	46 x 24	1/4"	5,37
5,00	50 x 26	1/4"	5,37
5,50	50 x 26	1/4"	5,86
6,00	50 x 26	1/4"	5,86
6,50	50 x 30	1/4"	5,86
6,80	50 x 30	1/4"	5,86
7,00	50 x 30	1/4"	5,86
7,50	51 x 32	1/4"	6,63
8,00	51 x 32	1/4"	6,63
8,50	53 x 33	1/4"	6,63
9,00	53 x 33	1/4"	8,01
9,50	54 x 38	1/4"	8,01
10,00	54 x 38	1/4"	8,01
10,20	54 x 38	1/4"	8,01

BROCAS BIDIAMETRALES

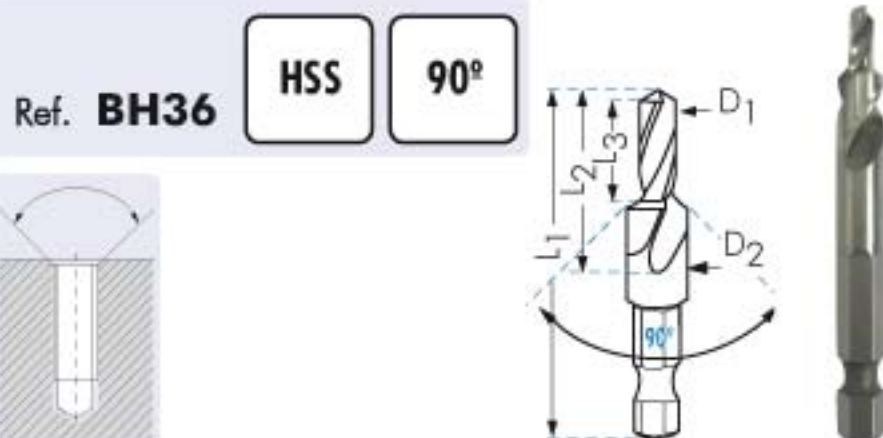

	BH36						
	D ₂ mm.	D ₁ mm.	L ₁ x L ₂ mm.	L ₃ mm.		€	
BH36M2	M2	2,3	1,6	35 x 6,5	5	1/4"	29,44
BH36M3	M3	3,4	2,5	47 x 10,4	8	1/4"	31,93
BH36M4	M4	4,5	3,3	53 x 14,3	11	1/4"	31,87
BH36M5	M5	5,5	4,2	59 x 16,9	13	1/4"	37,58
BH36M6	M6	6,6	5,0	59 x 16,9	16	1/4"	40,69
BH36M8	M8	9,0	6,8	70 x 26,0	20	1/4"	52,47
BH36M10	M10	11,0	8,5	70 x 26,0	24	1/4"	64,91

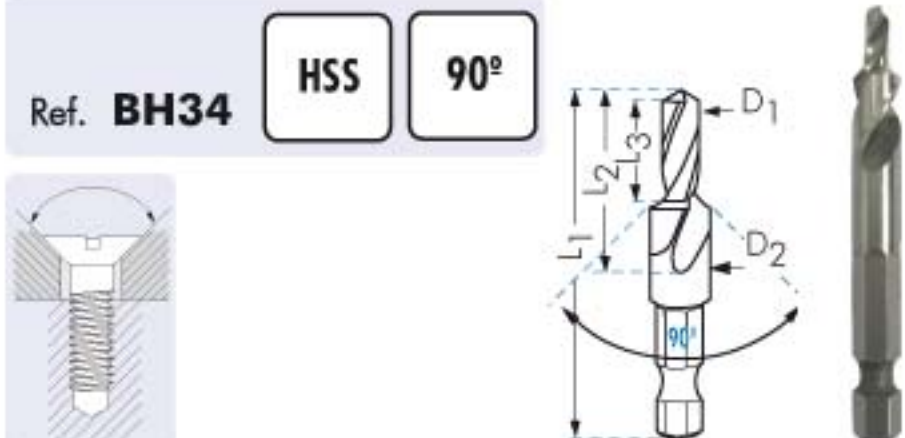



	BH34						
	D ₂ mm.	D ₁ mm.	L ₁ x L ₂ mm.	L ₃ mm.		€	
BH34M3	M3	6,0	3,2	47 x 10,4	8	1/4"	36,02
BH34M4	M4	8,0	4,3	53 x 14,3	11	1/4"	39,22
BH34M5	M5	10,0	5,3	59 x 16,9	13	1/4"	47,36
BH34M6	M6	12,0	6,4	59 x 16,9	16	1/4"	56,24
BH34M8	M8	16,0	8,4	70 x 26,0	20	1/4"	66,47
BH34M10	M10	20,0	10,5	70 x 26,0	24	1/4"	79,13

HERRAMIENTAS CON MANGO HEXAGONAL 1/4"

BROCA-MACHOS AVELLANADORES

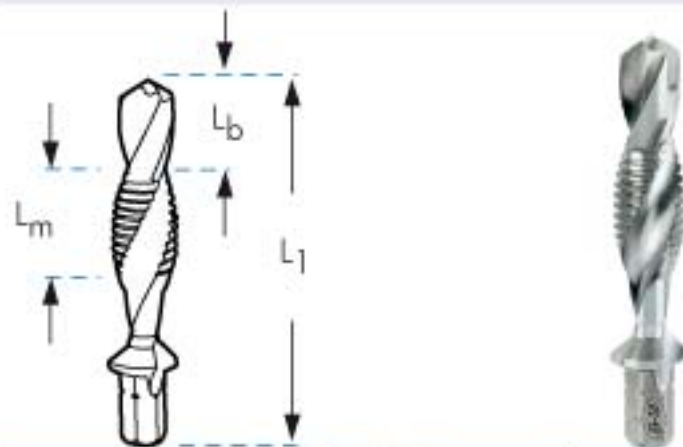
Ref. **MAHM** **HSS-G**  Disponible con mango hexagonal con cuello bajo demanda.





 	$L_1 \times L_b \times L_m$ mm.		MAHM	€
M 3 x 0,50	36 x 5 x 6	1/4"		14,57
M 4 x 0,70	39 x 6 x 7	1/4"		14,57
M 5 x 0,80	41 x 8 x 8	1/4"		14,57
M 6 x 1,00	44 x 8 x 10	1/4"		14,57
M 8 x 1,25	50 x 10 x 11	1/4"		20,15
M 10 x 1,50	59 x 11 x 11	1/4"		24,30

BROCA HSS-G

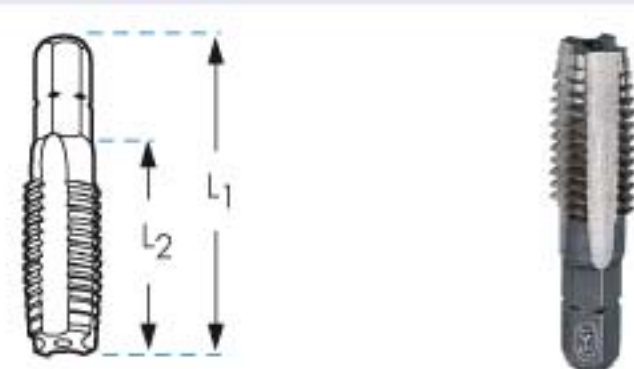
Ref. **M** **HSS-G**  Disponible con mango hexagonal con cuello bajo demanda.



 	$L_1 \times L_2$ mm.		M	€
M 3 x 0,50	33 x 11	1/4"		5,43
M 4 x 0,70	35 x 12	1/4"		5,43
M 5 x 0,80	36 x 15	1/4"		6,91
M 6 x 1,00	39 x 18	1/4"		6,91
M 8 x 1,25	40 x 19	1/4"		9,58
M 10 x 1,50	41 x 21	1/4"		11,83

AVELLANADORES DE 3 CORTES

Ref. **AV22** **HSS-G**  Disponible con mango hexagonal con cuello bajo demanda.

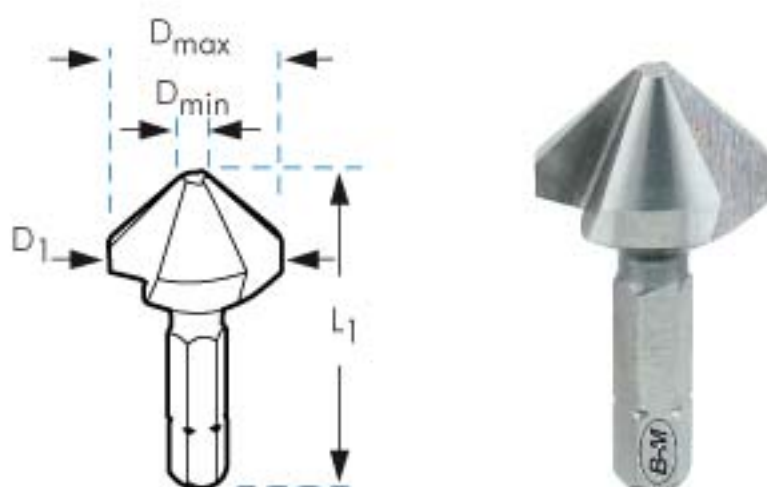

D_1 mm.	L_1 mm.	$D_{min} - D_{max}$ mm.		AV22	€
6,30	31	1,50 - 5,8	1/4"		13,82
8,30	31	2,00 - 7,8	1/4"		13,82
10,40	34	2,50 - 10,0	1/4"		14,81
12,40	35	2,80 - 12,0	1/4"		15,79
16,50	40	3,20 - 16,0	1/4"		16,91
20,50	41	3,50 - 20,0	1/4"		20,30

AVELLANADORES PARA DESBARBAR

Ref. **AV1...CR** **HSS**  

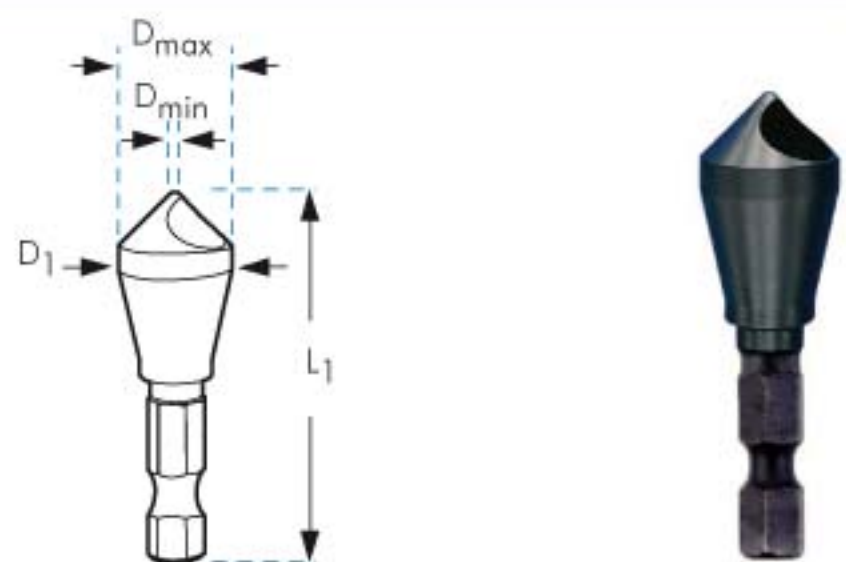

	D_1 mm.	L_1 mm.	$D_{min} - D_{max}$ mm.		AV1..CR	€
AV101CR	10,00	45	2,0 - 5,0	1/4"		13,83
AV102CR	14,00	48	5,0 - 10,0	1/4"		17,28
AV103CR	20,00	65	10,0 - 15,0	1/4"		30,95
AV104CR	27,00	85	15,0 - 20,0	1/4"		55,29

Disponible broca avellanadora helicoidal y broca escalonada con mango hexagonal 1/4". Consultar páginas 105 y 108

HERRAMIENTAS CON MANGO HEXAGONAL 1/4"

BROCA PARA PARED

Ref. **BWH**



				BWH
	∅ mm.	L ₁ x L ₂ mm.		€
BWH03	3	70 x 30	1/4"	2,10
BWH04	4	70 x 30	1/4"	2,33
BWH05	5	85 x 45	1/4"	2,63
BWH06	6	100 x 50	1/4"	2,93
BWH07	7	100 x 50	1/4"	3,30
BWH08	8	120 x 70	1/4"	3,98
BWH09	9	120 x 70	1/4"	4,58
BWH10	10	120 x 70	1/4"	5,33
BWH11	11	150 x 80	1/4"	6,38
BWH12	12	150 x 80	1/4"	7,50
BWH13	13	150 x 80	1/4"	8,63
BWH14	14	150 x 80	1/4"	10,05

BROCA PARA MADERA

Ref. **BMH**

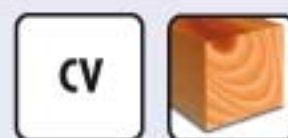

				BMH
	∅ mm.	L ₁ x L ₂ mm.		€
BMH03	3	59 x 35	1/4"	1,28
BMH04	4	74 x 41	1/4"	1,35
BMH05	5	82 x 55	1/4"	1,33
BMH06	6	88 x 58	1/4"	1,80
BMH07	7	110 x 70	1/4"	2,04
BMH08	8	110 x 70	1/4"	2,12
BMH09	9	110 x 70	1/4"	2,21
BMH10	10	115 x 75	1/4"	2,45
BMH11	11	135 x 85	1/4"	2,86
BMH12	12	135 x 85	1/4"	3,35
BMH13	13	135 x 90	1/4"	3,68
BMH14	14	145 x 95	1/4"	4,57



REFERENCIA	BWH9318	BWH9327	BWH9319	BMH9335	BMH9333
Nº BROCAS	5	5	8	5	8
APLICACIÓN	PARED	PARED	PARED	MADERA	MADERA
CONTENIDO	∅ 3-4-5-6-8 mm.	∅ 4-5-6-8-10 mm.	∅ 3-4-5-6-7-8-9-10 mm.	∅ 3-4-5-6-8 mm.	∅ 3-4-5-6-7-8-9-10 mm.
P.V.P. €	18,60	22,90	25,70	11,00	14,50

ESTUCHES DE HERRAMIENTAS CON MANGO HEXAGONAL 1/4"



Ref. **EB**



Ref. **EMBP**

CONTENIDO					P.V.P. €
EM	M3 - M4 - M5 - M6 M8 - M10	-	-	-	47,30
EMBP	M3 - M4 - M5 - M6 M8 - M10	∅ 2,50 - 3,30 - 4,20 5 - 6,80 - 8,50	-	-	71,37
EBM	-	-	M3 - M4 - M5 - M6 M8 - M10	-	101,40
EA	-	-	-	∅ 6,30 - 8,30 - 10,40 12,40 - 16,50 - 20,50	91,17
EB	-	∅ 1 - 10 mm. x 0,50	-	-	80,04